

# 'INTERRA

---

ITR901-002 – KNX LINE COUPLER

## Product Manual



Information contained in this publication regarding device applications and the like is provided only for your convenience and may be superseded versions by updates. It is your responsibility to ensure that your application meets with your specifications.

INTERRA MAKES NO REPRESENTATIONS OR WARRANTIES OF ANY KIND WHETHER EXPRESS OR IMPLIED, WRITTEN OR ORAL, STATUTORY OR NONSTATUTORY, RELATED TO THE INFORMATION INCLUDING BUT NOT LIMITED TO ITS CONDITION, QUALITY, PERFORMANCE, MERCHANTABILITY OR FITNESS FOR PURPOSE.

Interra disclaims all liability arising from this information and its use. Use of Interra devices in life support and / or safety applications is entirely at the buyer's risk, and the buyer agrees to defend, indemnify and hold harmless Interra from any and all damages, claims, suits, or expenses resulting from such use. No licenses are conveyed, implicitly or otherwise under any Interra intellectual rights.

## Trademarks

The Interra name and logo and the Interra ITR901-002 KNX Line Coupler are registered trademarks of Interra Technology in Turkey and other countries.

All other trademarks mentioned herein are property of the Interra Technology.

© 2019, Interra, Printed in Turkey, All Rights Reserved.



Printed on recycled paper.

**TS EN ISO 9001:2008**

---

## TO OUR CUSTOMERS

---

One of our most important aims is to provide you with the best documentation possible to use successfully your Interra products. Focusing of this, we will keep on improving our documentation to better suit your needs. Our publications will be updated as new volumes as soon as changes are introduced.

If you have any questions or comments regarding this publication, do not hesitate to contact us:

E-mail: [info@interra.com.tr](mailto:info@interra.com.tr)

Tel: +90 (216) 326 26 40 Fax: +90 (216) 324 25 03

### Most Current Product Manual

To obtain the most up-to-date version of this product manual, please visit our Web site at:

<http://www.interra.com.tr>

You can determine the version of an Interra document examining its literature number found on the bottom right corner of any page.

The first two letters of the literature are the type of document. The numbers that follow are the creation date of the document and the last letter is the version (e.g., PM181017001A is the version A of a product manual created on the date 17/10/18.)

## CONTENTS

1.1.) Front Panel .....	6
1.2.) LED Indication.....	7
1.3.) Device Commissioning.....	8
1.4.) General Features .....	8
2.1) TP Coupler Application .....	9
2.2) TP Repeater Application.....	10
2.3) KNX Network Installation .....	11
2.3.1) Physical Address Topology .....	11
2.3.2) KNX Topology .....	12
2.4) Programming.....	13
2.4.1) Programming Button.....	13
2.4.2) Physical Address Assignment .....	13
2.5) Special Functions.....	14
2.5.1) Manual Function .....	14
2.5.2) Restore Factory Settings.....	14
2.5.3) LED Status Display .....	14
3.1) General .....	15
3.2) Main Line .....	16
3.3) Subline .....	17
4.1) General .....	19
4.2) Main Line .....	19
4.3) Subline .....	20
5.) TECHNICAL DRAWINGS .....	22

## 1.) PRODUCT DESCRIPTION

The KNX TP Media Coupler ITR901-002 works as a KNX line/area coupler to provide a bi-directional data connection between two KNX TP lines/areas. KNX TP main line and KNX TP subline are coupled having a galvanic isolation in between.

Using the TP Coupler application, ITR901-002 can be used as a KNX TP line coupler to connect several KNX TP lines but also as a KNX TP area coupler to connect several TP areas or different KNX TP installation systems via a TP Backbone. Telegram filtering is accomplished according to the installation place in the hierarchy (Physically addressed Telegrams) and according to the built in filter tables for group communication (Group oriented Telegrams). For detailed diagnosis all operational modes/states are shown by a duo-LED display.

Using the TP Repeater application, ITR901-002 is able to extend a KNX TP line providing unfiltered data transfer and galvanic isolation between segments. Up to four line segments can form a single KNX TP line by connecting three ITR901-002 line repeaters. Each line segment requires its own KNX power supply unit.

To ease commissioning and troubleshooting the Manual Function for short-time telegram filter switch-off and special routing/repetition/confirmation settings are available.

**Note:** In this document, physically addressed telegrams are named Physical Telegrams, also group oriented telegrams are named Group Telegrams.

## 1.1.) Front Panel

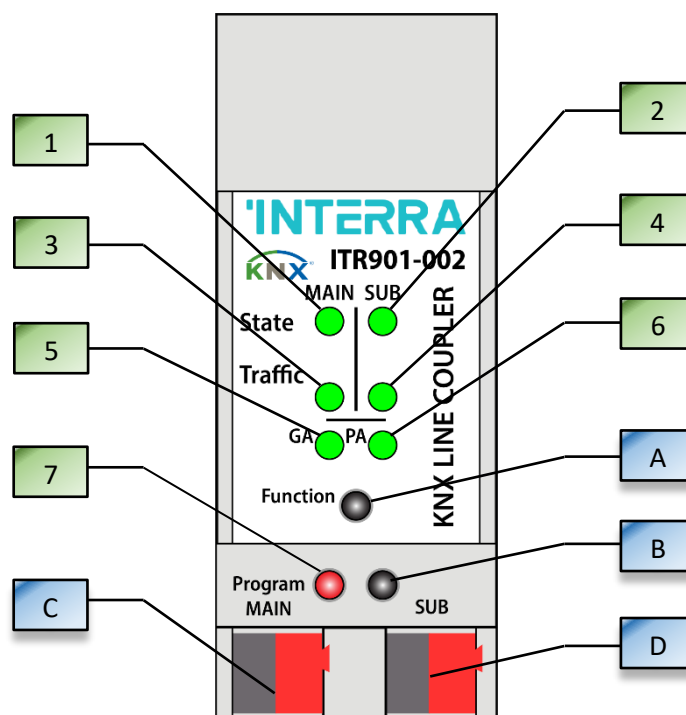

Fig 1: Front View

The following table shows information and descriptions of the front panel.

LED	BUTTONS / CONNECTORS
1. Bus State KNX TP (Main Line)	A. Function Button
2. Bus State KNX TP (Subline)	B. Program Button
3. Telegram Traffic KNX TP (Main Line)	C. KNX TP Main Line Connector
4. Telegram Traffic KNX TP (Subline)	D. KNX TP Subline Connector
5. Group Address(GA) Routing (0...13)	
6. Physical Address(PA) Routing	
7. Programming	

Table 1 : LED & Buttons Descriptions

## 1.2.) LED Indication

If ITR901-002 is used as Line Coupler without physical address x.y.0, LED 6 (PA) that is showed at table 1, works not like described here.

NUMBER	LED	COLOUR	DESCRIPTION
1	Bus State KNX TP (Main Line)	Green	Main Line OK.
		Red	Manual Function Active.
2	Bus State KNX TP (Subline)	Green	Subline OK.
		Off	Subline not connected.
3	Telegram Traffic KNX TP (Main Line)	Blinking Green	Telegram traffic extent indicated by blinking.
		Blinking Red	Transmission error.
		Off	No telegram traffic.
4	Telegram Traffic KNX TP (Subline)	Blinking Green	Telegram traffic extent indicated by blinking.
		Blinking Red	Transmission error.
		Off	No telegram traffic.
5	Group Address Routing	Green	Filter table active.
		Orange	Route all.
		Red	Block all.
		Off	Routing of Group Telegrams is different on main line and subline.
6	Physical Address Routing	Green	Filtering active.
		Orange	Route all.
		Red	Block all.
		Off	Routing of Physical telegrams is different on main line and subline.
7	Programming	Red	Program Mode active.
		Off	Program Mode not active.

## 1.3.) Device Commissioning

The default settings of the device are :

- All telegrams are blocked due to the filter table is not defined.
- The Manual Function switch-off time is 120 min.
- Physical address is "15.15.0".
- Never connect the device to 230V.

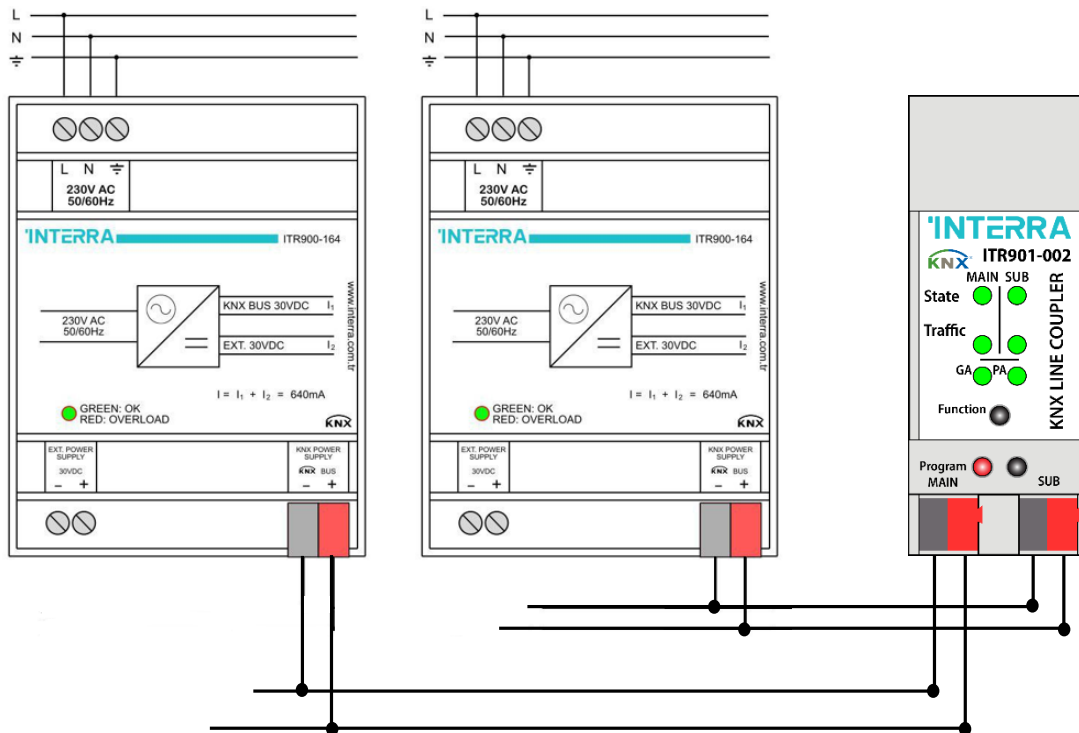

Fig 2: Connection Scheme

## 1.4.) General Features

- ITR901-002 KNX IP Router supports extended frames and long telegrams up to 240 bytes APDU length.
- ACK sending on sent out messages is ETS configurable.
- When there is no IACK response on the subline the Interra KNX IP Router is able to repeat messages up to three times. Repetitions can be configured for both Physical Telegrams and Group Telegrams via ETS (to ease troubleshooting). After an IACK response no repetition is following and the negative IACK/BUSY failure mechanism is maintained.
- Automatic function for switching back to run-time telegram filtering after configurable suspension period. This avoids forgetting the reactivation of filtering.
- For an ETS configurable time period, it is possible to switch off telegram filtering by only pressing a button on the device front panel. Without additional ETS download filtering is suspended. This is necessary for running fast diagnostics on site.



- Temporarily suspending telegram filtering eases commissioning and debugging. Without ETS download temporary access to other lines becomes possible.
- In networks with high busload the internal amount of communication buffers are capable of smoothing peaks in the communication load course.
- ITR901-002's ETS database entries are available for ETS4 and later.

## 2.) OPERATIONAL DESCRIPTION

In network installations ITR901-002 can be used as KNX TP area/line coupler or KNX TP line repeater. With its default settings, device operates as is supposed to.

### 2.1) TP Coupler Application

When ITR901-002 receives telegrams (for example during commissioning) that use Physical Addresses as destination addresses, it compares the Physical Addresses of the receiver with its own physical address and decides on that whether it has to route the telegrams or not.

When ITR901-002 receives telegrams that use group addresses as destination addresses, it reacts in accordance with the parameter settings. During normal operation (with default settings), ITR901-002 only routes telegrams whose group addresses are entered in the filter table. If ITR901-002 routes a telegram and does not receive an acknowledgement, or if a bus device discovers a transmission error, the coupler repeats telegrams up to three times (depending on the corresponding parameter that is set by ETS). With the parameters "Repetitions if errors...", this function can be configured separately for each line. It is recommended to use the default parameter setting.

If not already configured as "Line Coupler", the ETS application program "TP Coupler" has to be downloaded to the device. Under the Information tab the configuration setting can be changed by the drop-down menu "Change Application Program". After changing the configuration setting the filter table entries can be added manually. Updating the application program version can also be done here.

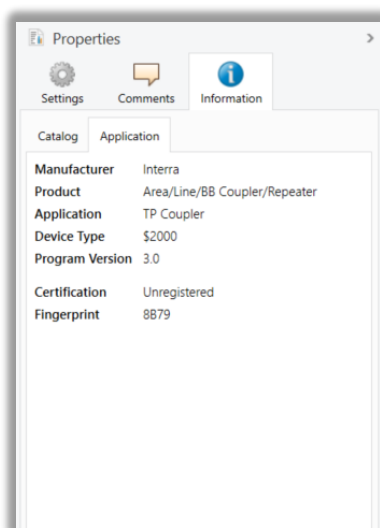

Fig 3: TP Coupler Application Program

## 2.2) TP Repeater Application

Any received telegram is routed to all lines irrespective of in which line it is processed. Line repeaters make no use of a filter table. It is therefore not important whether the telegram is generated within a line or whether it is sent from an upper line to a lower line via a coupler.

When a transmission error occurs, i.e. due to a wrong receiving Physical Address, the line repeater is able to repeat the telegram up to three times. With the parameter "Physical: Repetition if errors ..." this function can be configured separately for each line.

In case of routing a Group Telegram without receiving an acknowledgement, the line repeater repeats telegrams up to three times. With the parameter "Group: Repetitions if errors...", this function can be configured separately for each line.

If not already configured as Line/Area/BB Repeater, the ETS application program "TP repeater" has to be downloaded to the device. Under the Information tab the configuration setting can be changed by the drop-down menu "Change Application Program". After changing the configuration setting the filter table entries can be added manually. Updating the application program can also be done here.

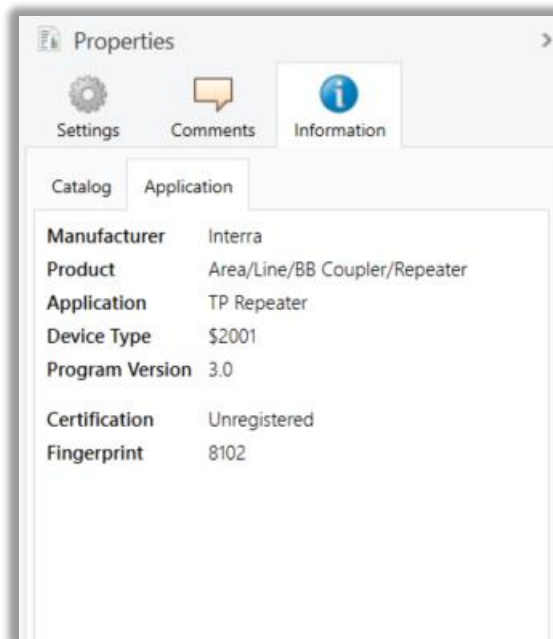

Fig 4: TP Repeater Application Program

## 2.3) KNX Network Installation

### 2.3.1) Physical Address Topology

For line coupler functionality in a KNX network ITR901-002 has to use the correct Physical Address of a line coupler (X.Y.0,  $1 \leq X \text{ \& } Y \leq 15$ ). In ETS up to 225 addresses can be defined (from 1.1.0 to 15.15.0). For area coupler functionality in a KNX network ITR901-002 has to use the correct Physical Address of an area coupler (X.0.0,  $1 \leq X \leq 15$ ). In ETS up to 15 areas can be defined. If ITR901-002 is used in a KNX system for both purposes, it is only necessary to ensure that the ITR901-002 used as a line coupler has a line coupler address assigned from a free addressing area. Following figure illustrates the ITR901-002 router topology for KNX lines and KNX areas.

**Ex :** If an area coupler with address 1.0.0 already exists on the backbone no line coupler with address 1.X.0,  $1 \leq X \leq 15$  can be added here. Even if no line coupler with address 1.1.0 exists on the subline of the 1.0.0 area coupler. Vice versa, if a line coupler with address 1.1.0 already exists in the installation no area coupler with address 1.0.0 can be added.

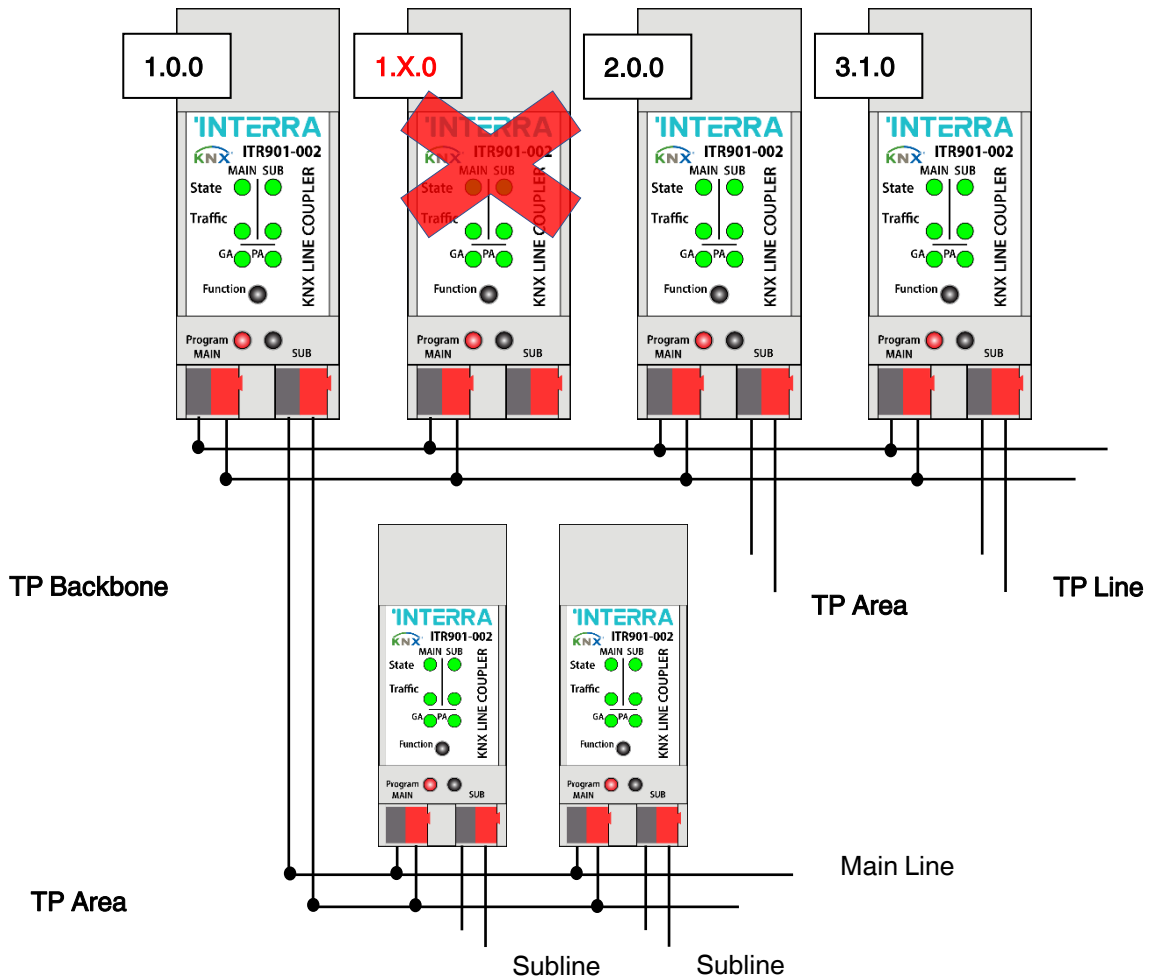

Fig 5: Interra KNX TP Network Topology

## 2.3.2) KNX Topology

Via a line/area coupler up to 15 lines can be connected to a main line called an area. It is possible to have up to 64 bus devices on one line. With use of line repeaters a line can theoretically be extended to 255 bus devices. This means up to four line segments can form a single KNX TP line. But it is common practice on exceeding 64 bus devices to insert a new line instead of extending the originating one.

**Note:** Each line segment requires its own KNX power supply unit.

**Note:** Using repeaters on the backbone or on the main line is not allowed.

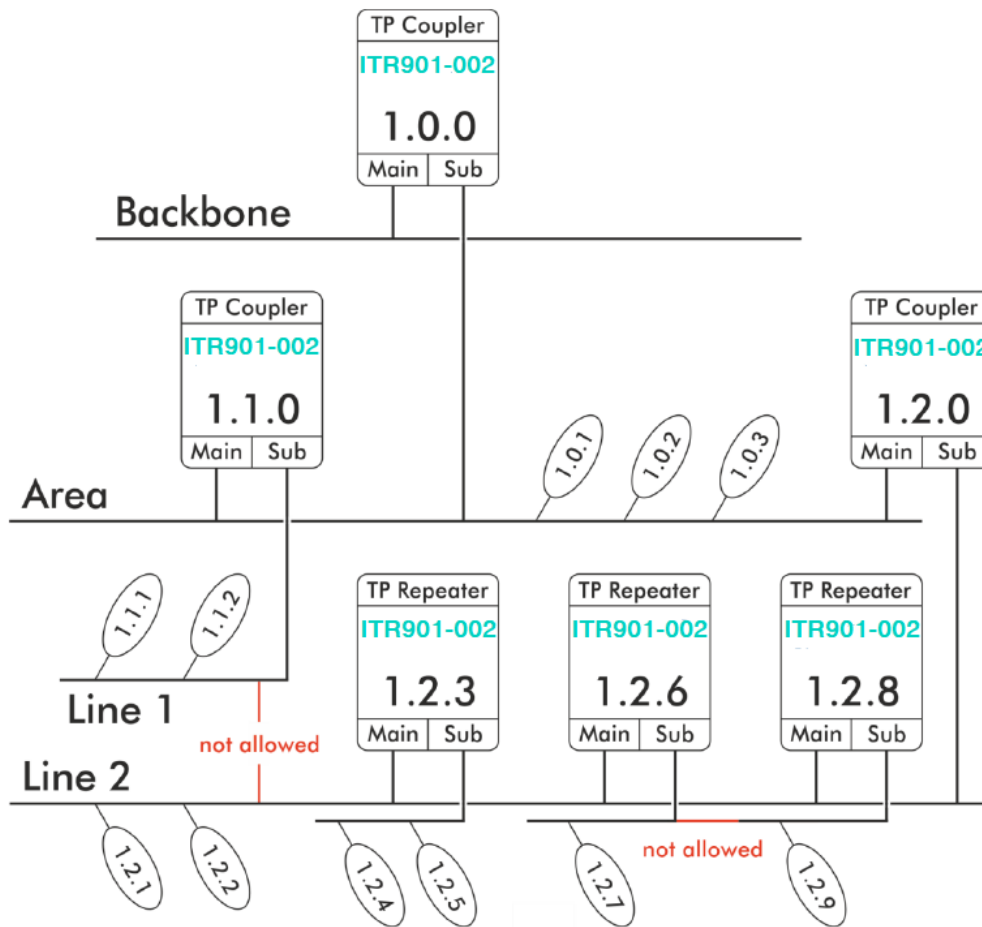

Fig 6: ITR901-002 NetworkTopology

The free tree structure of the KNX topology prevents problems caused by circling telegrams and heavy bus load. So, interconnection between lines is strictly forbidden.

## 2.4) Programming

As mentioned before, it is possible to program the device with ETS. There are several things to be known in order to activate the device. These are described in the headings below.

### 2.4.1) Programming Button

To download the desired physical address or an ETS setting the Program Button must be pressed first. Successive pressing the Program Button will turn on and off the Program Mode. According to table 1, LED 7 lighting in red colour indicates Program Mode is active. When Program Mode is active ETS recognizes the device of interest for downloading.

### 2.4.2) Physical Address Assignment

To commission the device an interface connection (IP, USB) to the KNX bus system is required. The device is supplied with the individual physical address 15.15.0. The KNX product database entry (available for ETS4 and higher) can be downloaded from the Interra website and from the KNX Online Catalog. With the ETS the physical address can be assigned to the device by setting the desired address in the properties window of the ETS. After starting the ETS download and then pressing the Program Button the device restarts itself.

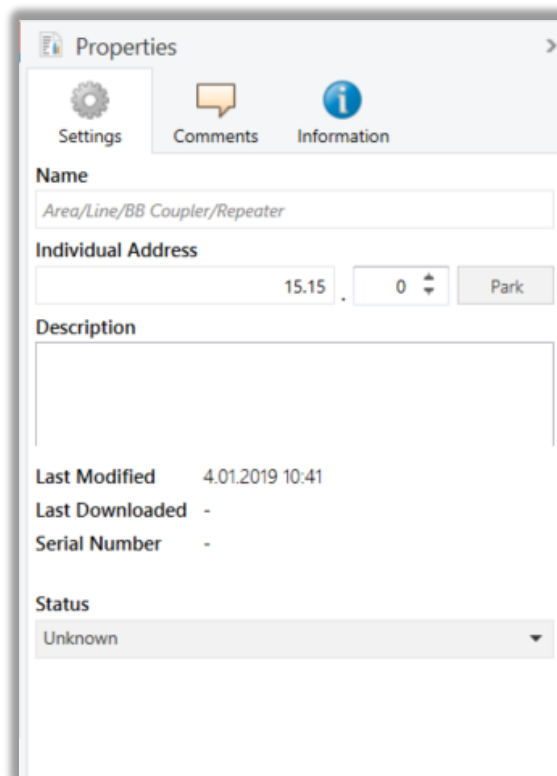

Fig 7: ETS Properties Window

**Note:** In this document only the term “physical address” is used. The term “physical address” means the KNX physical address as well as the ETS individual address. Both terms are used by the KNX organisation interchangeably.

## 2.5) Special Functions

The Function Button activates the device's special functions. Manual function and Factory Reset can be activated. It depends on time/number/state the Function Button is being pressed.

### 2.5.1) Manual Function

During normal operation a rather short press ( $\approx 3$  sec) activates the Manual Function. When the Manual Function is active, either all Physical Telegrams or all Group Telegrams or both pass the ITR901-002 without filtering. After the Switch-off time period has elapsed ITR901-002 automatically switches back to normal operation. To configure the Manual Function and set the Switch-off time use the General parameter tab like shown in chapters 3.1 and 4.1. After switching back from Manual Function to normal operation the latest downloaded parameter setting / filter table entries are active again.

### 2.5.2) Restore Factory Settings

A very long press ( $\approx 15$  sec) of the Function Button soon followed by a second press for some seconds executes the Factory Reset.

After the first press the LED display lights different with mixed colour. After the second press all parameters will be set to factory default (includes physical address). Subsequently, LEDs show the normal display again.

### 2.5.3) LED Status Display

The following table shows the manual function LED states.

NUMBER	LED	COLOUR	DESCRIPTION
1	Bus State KNX TP (Main Line)	Green	
2	Bus State KNX TP (Subline)	Orange	If connected.
5	Group Address Routing	Orange	
6	Physical Address Routing	Orange	

**Table 2 : LED Status Display for Manual Function**

The following table shows the LED status for returning to the factory settings after the first press of the button.

NUMBER	LED	COLOUR	DESCRIPTION
1	Bus State KNX TP (Main Line)	Orange	
2	Bus State KNX TP (Subline)	Orange	Lights red if not connected.
5	Group Address Routing	Orange	
6	Physical Address Routing	Orange	

**Table 3 : LED Status Display for Factory Reset After First Button Press**

### 3.) ETS DATABASE PARAMETERS COUPLER OPERATION

All images related to the device used in this section are taken from ETS5 version.

#### 3.1) General

The following shows the ETS parameters to be seen when entered to General Tab Parameter Page.

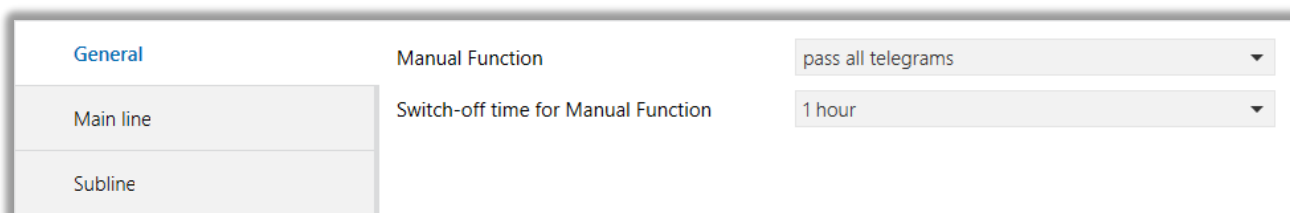

**Fig 8: General Tab Parameter Page**

PARAMETER	DESCRIPTION	VALUES
<b>Manual Function</b>	Configuration setting for telegram routing when the Manual Function is active.	disabled <b>pass all telegrams</b> pass all Physical address telegrams pass all Groups address telegrams
<b>Switch-off time for Manual Function</b>	After expiry of this period the Manual Function is switched off automatically.	10 mins, <b>1 hour</b> , 4 hours, 8 hours

### 3.2) Main Line

For Group Telegrams and Physical Telegrams the setting “transmit all” is intended only for testing purposes. Please do not use for normal operation.

**Note:** If the parameter “Send confirmation on own telegrams” is set to “yes”, the ITR901-002 systematically sends an ACK on any own routed telegram.

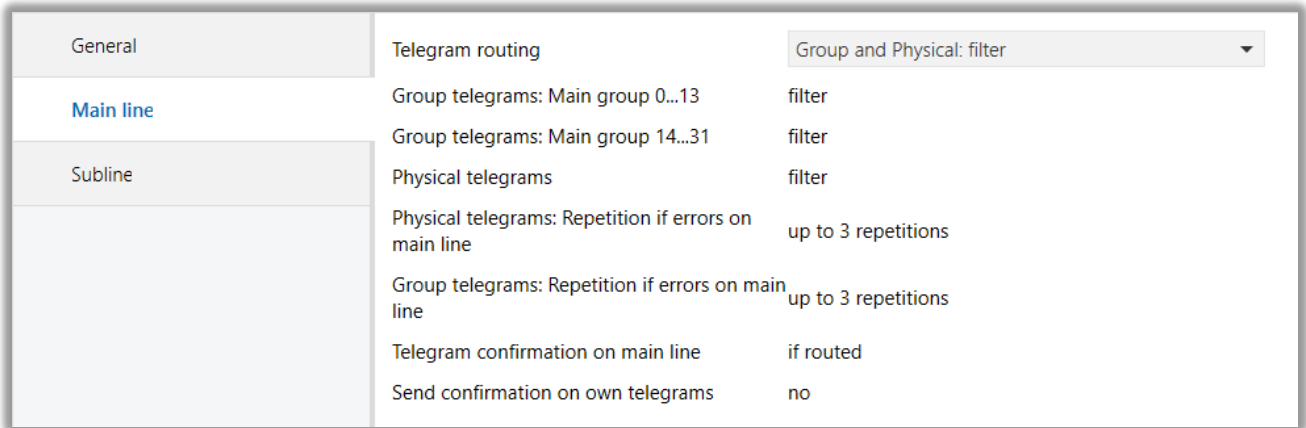

Fig 9: Main Line Tab Parameter Page

PARAMETER	DESCRIPTION	VALUES
<b>Telegram routing</b>	<p><b>block</b> : No telegrams are routed.</p> <p><b>filter</b> : Telegrams entered in the filter table are routed.</p> <p><b>route</b> : All telegrams are routed.</p> <p><b>configure</b> : The following parameters that will be shown must be set manually.</p>	<p>Group: filter, Physical: block</p> <p><b>Group and Physical: filter</b></p> <p>Group: route, Physical: filter</p> <p>Group and Physical: route</p> <p>configure</p>
<b>Group telegrams : Main group 0...13*1</b>	<p><b>transmit all</b> : Group telegrams (main group 0...13) are all routed.</p> <p><b>block</b> : Group telegrams (main group 0...13) are all blocked.</p> <p><b>filter</b> : Group telegrams (main group 0...13) are routed if entered in the filter table.</p>	<p>transmit all (not recommended)</p> <p>block</p> <p><b>filter</b></p>
<b>Group telegrams : Main group 14...31*1</b>	<p><b>transmit all</b> : Group telegrams (main group 14...31) are all routed.</p> <p><b>block</b> : Group telegrams (main group 14...31) are all blocked.</p> <p><b>filter</b> : Group telegrams (main group 14...31) are routed if entered in the filter table.</p>	<p>transmit all (not recommended)</p> <p>block</p> <p><b>filter</b></p>



PARAMETER	DESCRIPTION	VALUES
<b>Physical telegrams</b>	<b>transmit all</b> : All of the Physical Telegrams are routed. <b>block</b> : All of the Physical Telegrams are blocked. <b>filter</b> : Depending on the physical address, physical telegrams are routed.	transmit all (not recommended) block <b>filter</b>
<b>Physical telegrams : Repetition if errors on main line</b>	After main line transmission error (e.g. due to missing receiver) Physical telegrams : <b>no</b> : Are not repeated. <b>up to 3 repetitions</b> : Are repeated max. 3 times. <b>one repetition</b> : Are repeated once.	no <b>up to 3 repetitions</b> one repetition
<b>Group telegrams : Repetition if errors on main line</b>	After main line transmission error (e.g. due to missing receiver) Group telegrams : <b>no</b> : Are not repeated. <b>up to 3 repetitions</b> : Are repeated max. 3 times. <b>one repetition</b> : Are repeated once.	no <b>up to 3 repetitions</b> one repetition
<b>Telegram confirmation on main line</b>	<b>if routed</b> : Routed telegrams to the subline are confirmed by an ACK on the main line. <b>always</b> : Each telegram on the mainline is confirmed by an ACK.	<b>if routed</b> always
<b>Send confirmation on own telegrams</b>	<b>yes</b> : Telegrams sent out to the mainline are confirmed by added ACK. <b>no</b> : No ACK confirmation.	yes <b>no</b>

\*1This parameter, is only visible when "Telegram routing" parameter is set to "configure".

### 3.3) Subline

For Group Telegrams and Physical Telegrams the setting "transmit all" is intended only for testing purposes. Please do not use for normal operation.

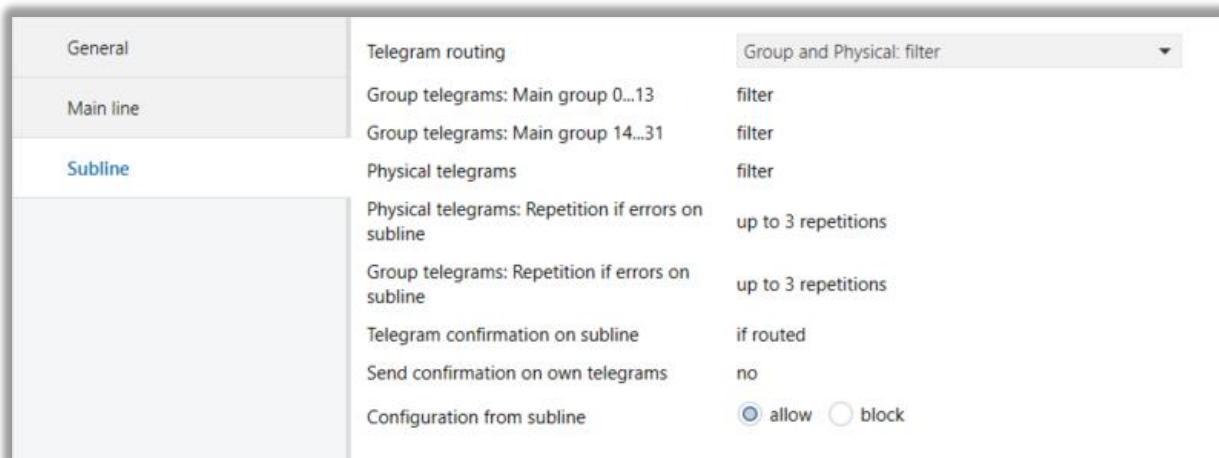

Fig 10: Subline Tab Parameter Page

PARAMETER	DESCRIPTION	VAUES
Telegram routing	<p><b>block</b> : No telegrams are routed.</p> <p><b>filter</b> : Telegrams entered in the filter table are routed.</p> <p><b>route</b> : All telegrams are routed.</p> <p><b>configure</b> : The following parameters must be set manually.</p>	Group: filter, Physical: block <b>Group and Physical: filter</b> Group: route, Physical: filter Group and Physical: route configure
Group telegrams : Main group 0...13* <sup>1</sup>	<p><b>transmit all</b> : Group telegrams (main group 0...13) are all routed.</p> <p><b>block</b> : Group telegrams (main group 0...13) are all blocked.</p> <p><b>filter</b> : Group telegrams (main group 0...13) are routed if entered in the filter table.</p>	transmit all (not recommended) block <b>filter</b>
Group telegrams : Main group 14...31* <sup>1</sup>	<p><b>transmit all</b> : Group telegrams(main group 14...31) are all routed.</p> <p><b>block</b> : Group telegrams (main group 14...31) are all blocked.</p> <p><b>filter</b> : Group telegrams (main group 14...31) are routed if entered in the filter table.</p>	transmit all (not recommended) block <b>filter</b>
Physical telegrams	<p><b>transmit all</b> : Physical telegrams are all routed.</p> <p><b>block</b> : Physical telegrams are all blocked.</p> <p><b>filter</b> : Depending on the physical address, physical telegrams are routed.</p>	transmit all (not recommended) block <b>filter</b>
Physical telegrams : Repetition if errors on subline	After subline transmission error (e.g. due to missing receiver) Physical telegrams : <p><b>no</b> : Are not repeated.</p> <p><b>up to 3 repetitions</b> : Are repeated max. 3 times.</p> <p><b>one repetition</b> : Are repeated once.</p>	no <b>up to 3 repetitions</b> one repetition
Group telegrams : Repetition if errors on subline	After subline transmission error (e.g. due to missing receiver) Group telegrams : <p><b>no</b> : Are not repeated.</p> <p><b>up to 3 repetitions</b> : Are repeated max. 3 times.</p> <p><b>one repetition</b> : Are repeated once.</p>	no <b>up to 3 repetitions</b> one repetition
Telegram confirmation on subline	<p><b>if routed</b> : Routed telegrams to main line are confirmed by an ACK on the subline.</p> <p><b>always</b> : Each telegram on the subline is confirmed by an ACK.</p>	<b>if routed</b> always
Send confirmation on own telegrams	<p><b>yes</b> : Telegrams sent out to the subline are confirmed by added ACK.</p> <p><b>no</b> : No ACK confirmation.</p>	yes <b>no</b>
Configuration from subline	If blocked an ETS download to the device can occur only via main line.	<b>enable</b> disable

\*<sup>1</sup>This parameter, is only visible when the “Telegram routing” parameter is set to “configure”.

## 4.) ETS DATABASE PARAMETERS REPEATER OPERATION

All images related to the device used in this section are taken from ETS5 version.

### 4.1) General

The following shows the ETS parameters to be seen when entered to General Tab Parameter Page.

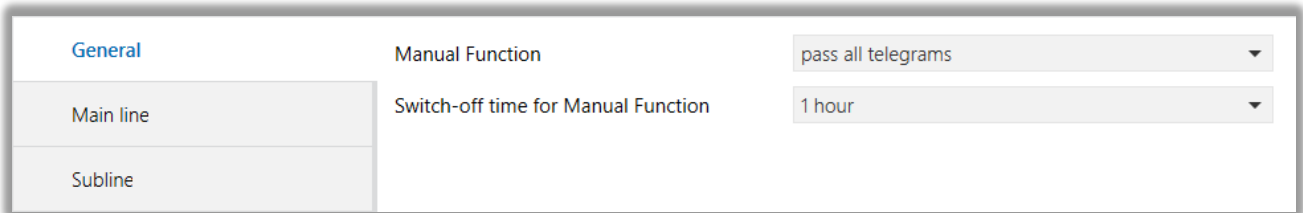

Fig 11: General Tab Parameter Page

PARAMETER	DESCRIPTION	VALUES
Manual Function	Configuration setting for telegram routing when the Manual Function is active.	disabled <b>pass all telegrams</b> pass all Physical address telegrams pass all Groups address telegrams
Switch-off time for Manual Function	After expiry of this time period, the Manual Function is switched off automatically.	10 mins, <b>1 hour</b> , 4 hours, 8 hours

### 4.2) Main Line

For Group Telegrams and Physical Telegrams the setting “transmit all” is intended only for testing purposes. Please do not use for normal operation. In addition, if the parameter “Send confirmation on own telegrams” is set to “yes”, the ITR901-002 systematically sends an ACK on any own routed telegram. Since the repeater does not use a filter table, it is useful to have an ACK sent along with routed telegrams.

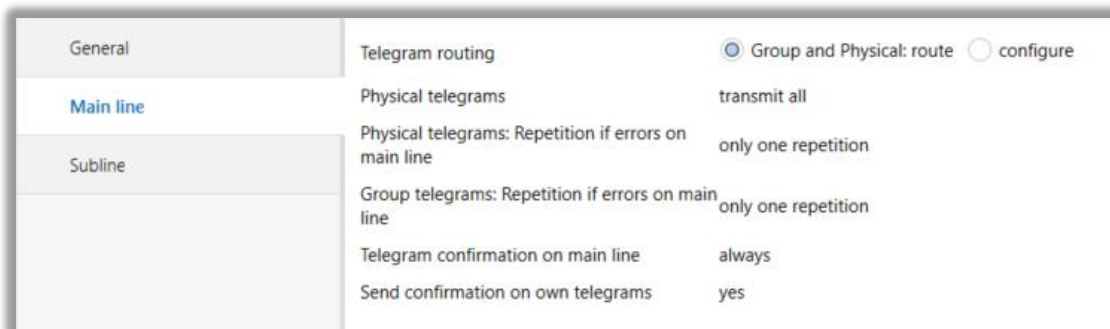

Fig 12: Main Line Tab Parameter Page

PARAMETER	DESCRIPTION	VALUES
Telegram routing	<b>route</b> : All telegrams are routed. <b>configure</b> : The following parameters must be set manually.	<b>Group and Physical: route</b> configure
Physical telegrams	<b>transmit all</b> : Physical telegrams are all routed. <b>block</b> : Physical telegrams are all blocked. <b>filter</b> : Depending on the physical address, physical telegrams are routed.	transmit all (not recommended) block <b>filter</b>
Physical telegrams : Repetition if errors on main line	After main line transmission error (e.g. due to missing receiver) Physical telegrams : <b>no</b> : Are not repeated. <b>up to 3 repetitions</b> : Are repeated max. 3 times. <b>one repetition</b> : Are repeated once.	no <b>up to 3 repetitions</b> one repetition
Group telegrams : Repetition if errors on main line	After main line transmission error (e.g. due to missing receiver) Group telegrams : <b>no</b> : Are not repeated. <b>up to 3 repetitions</b> : Are repeated max. 3 times. <b>one repetition</b> : Are repeated once.	no <b>up to 3 repetitions</b> one repetition
Telegram confirmation on main line	<b>if routed</b> : Routed telegrams to the subline are confirmed by an ACK on the main line. <b>always</b> : Each telegram on the mainline is confirmed by an ACK.	<b>if routed</b> always
Send confirmation on own telegrams	<b>yes</b> : Telegrams sent out to the mainline are confirmed by added ACK. <b>no</b> : No ACK confirmation.	yes <b>no</b>

### 4.3) Subline

For Group Telegrams and Physical Telegrams the setting “transmit all” is intended only for testing purposes. Please do not use for normal operation.

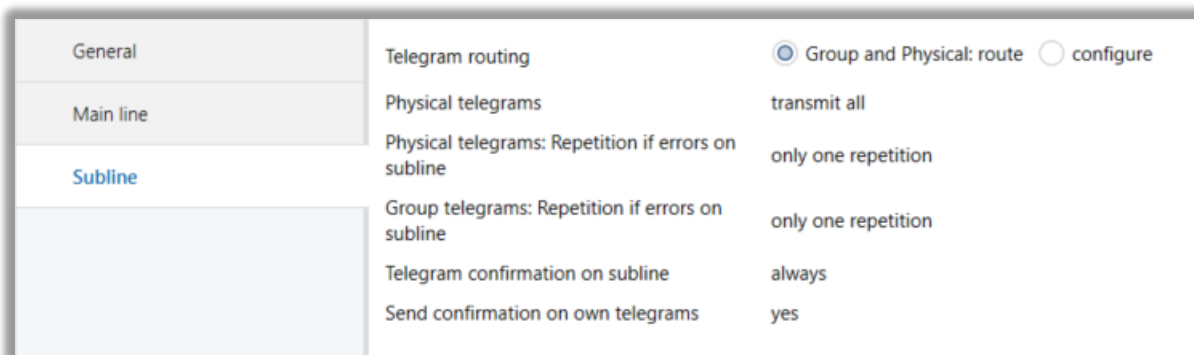

Fig 13: Subline Tab Parameter Page

PARAMETRE	DESCRIPTION	VALUES
Telegram routing	<b>route</b> : All telegrams are routed. <b>configure</b> : The following parameters must be set manually.	Group: filter, Physical: block Group and Physical: filter <b>Group: route, Physical: filter</b> Group and Physical: route configure
Physical telegrams	<b>transmit all</b> : Physical telegrams are all routed. <b>block</b> : Physical telegrams are all blocked. <b>filter</b> : Depending on the physical address, Physical telegrams are routed.	transmit all (not recommended) block <b>filter</b>
Physical telegrams : Repetition if errors on subline	After subline transmission error (e.g. due to missing receiver) Physical telegrams : <b>no</b> : Are not repeated. <b>up to 3 repetitions</b> : Are repeated max. 3 times. <b>one repetition</b> : Are repeated once.	no <b>up to 3 repetitions</b> one repetition
Group telegrams : Repetition if errors on subline	After subline transmission error (e.g. due to missing receiver) Group telegrams : <b>no</b> : Are not repeated. <b>up to 3 repetitions</b> : Are repeated max. 3 times. <b>one repetition</b> : Are repeated once.	no <b>up to 3 repetitions</b> one repetition
Telegram confirmation on subline	<b>if routed</b> : Routed telegrams to the main line are confirmed by an ACK on the main line. <b>always</b> : Each telegram on the subline is confirmed by an ACK.	<b>if routed</b> always
Send confirmation on own telegrams	<b>yes</b> : Telegrams sent out to the subline are confirmed by added ACK. <b>no</b> : No ACK confirmation.	yes <b>no</b>

## 5.) TECHNICAL DRAWINGS

All dimensions shown here are specified in mm. The total device width is standard 2 modules.

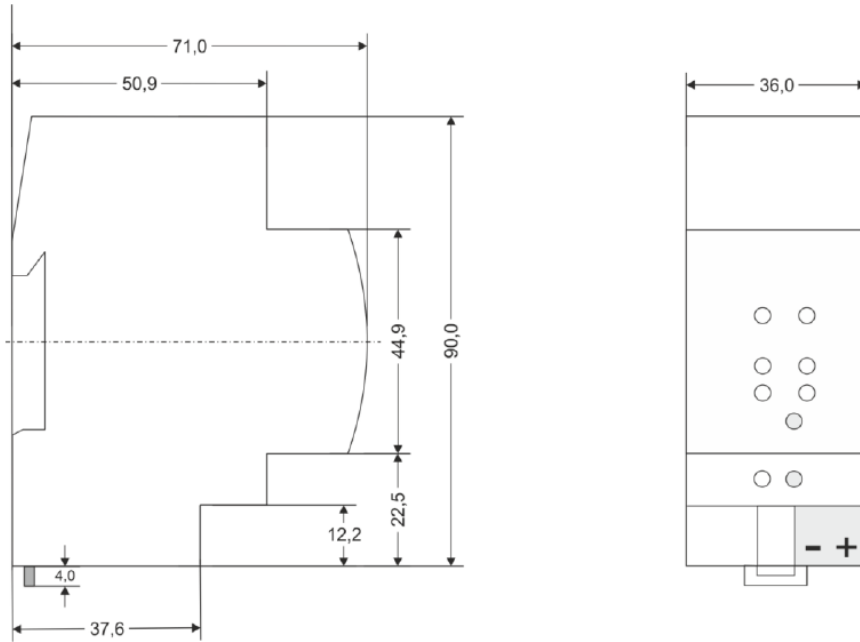

Fig 14: Drawings and Dimensions of the Device

---

---

## CONTACT INFORMATION

---

### THE INTERRA WEB SITE

Interra provides documentation support via our WWW site [www.interra.com.tr](http://www.interra.com.tr). This web site is used as a means to make files and information easily available to customers. Accessible by using your favorite Internet browser, the web site contains the following information:

- Information about our products and projects.
- Overview of Interra company and values.
- Product Support: Data sheets, product manuals, application descriptions, latest software releases, ETS databases and archived softwares.

### Europe, Turkey

#### KNX Line Coupler - Product Manual

Interra

Cumhuriyet mh. Kartal cd. No:95/1

Simkan Plaza 34876 Kartal/İstanbul

Tel: +90 (216) 326 26 40 Fax: +90 (216) 324  
25 03

Web adres: <http://www.interra.com.tr/>